

Concrete

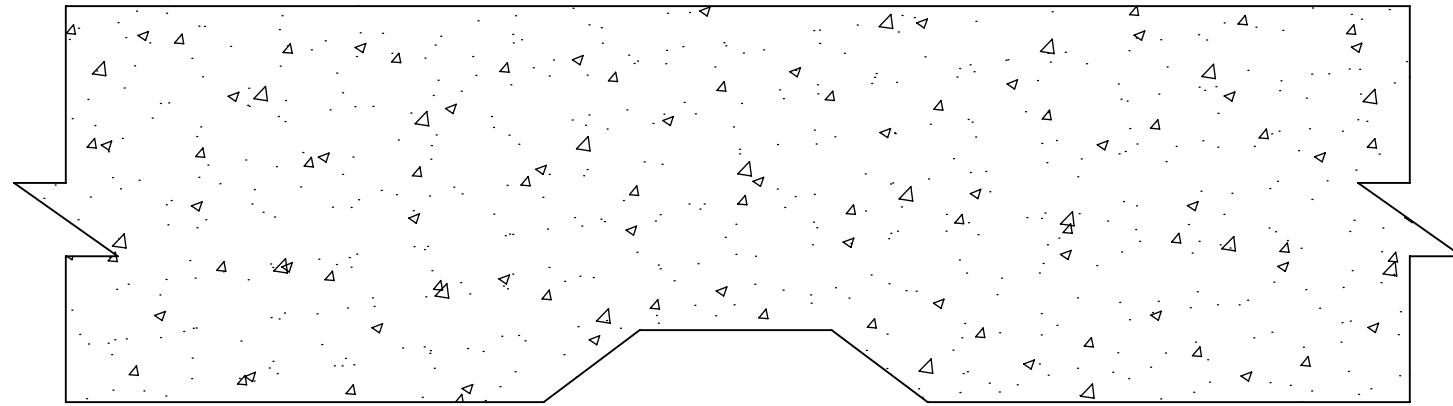

Reveal Strip

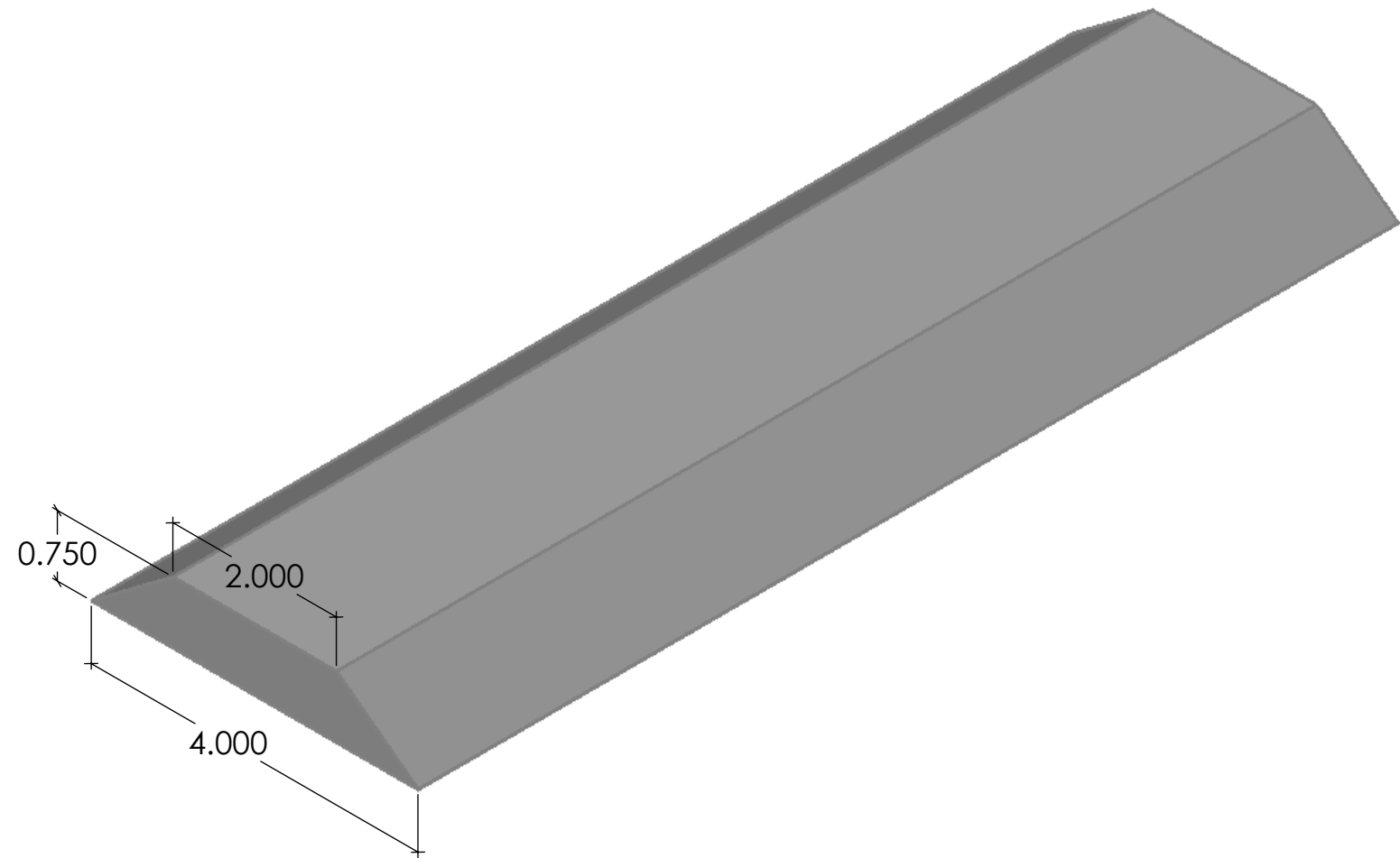

**FAST FORMLINERS CO.**  
1005 Miller Drive, St. Clair, MO 63077  
636-322-0080 Phone 636-322-0083 Fax  
www.fastformliners.com



DRAWN BY: Petr L. 4/29/2015  
**PROPRIETARY AND CONFIDENTIAL**  
THE INFORMATION CONTAINED IN THIS  
DRAWING IS THE SOLE PROPERTY OF  
FAST FORMLINERS. ANY  
REPRODUCTION IN PART OR AS A WHOLE  
WITHOUT THE WRITTEN PERMISSION OF  
FAST FORMLINERS IS PROHIBITED.

SHEET SIZE  
**11"x17"**  
DO NOT  
SCALE  
SHEET 1 OF 1

**20059**

20059Reveal

REV. 4/29/2015

NOTES:

APPROVAL SIGNATURE:

Please provide a signature in this box to indicate that this drawing has been approved and that FAST FORMLINERS may begin production.