

Concrete

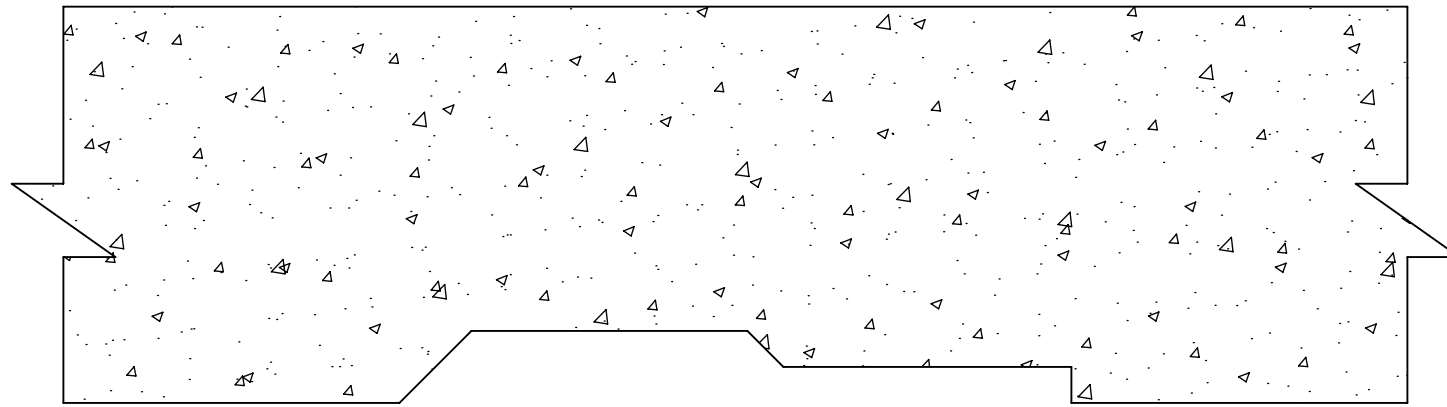

Reveal Strip

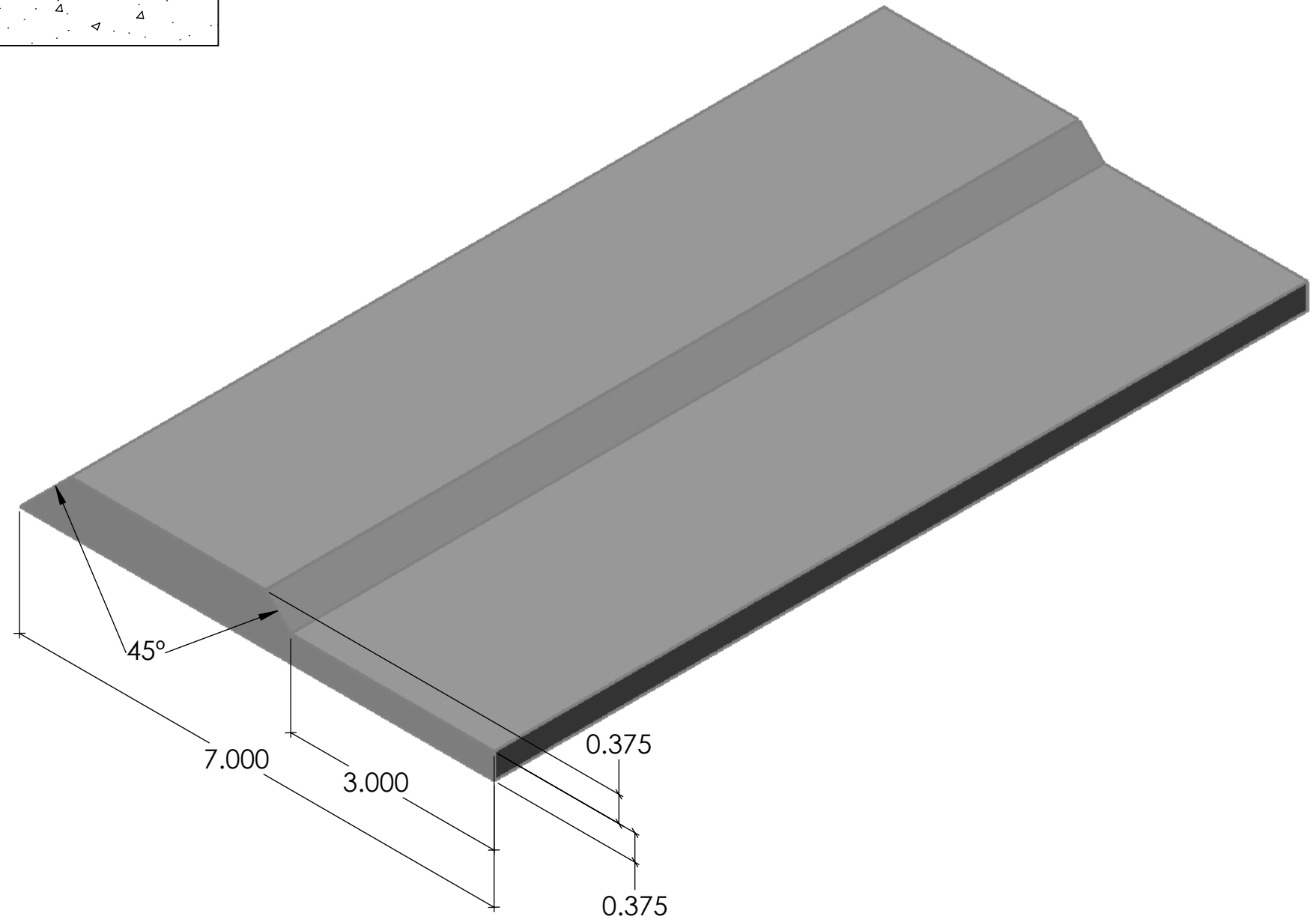

**FAST FORMLINERS CO.**  
 1005 Miller Drive, St. Clair, MO 63077  
 636-322-0080 Phone 636-322-0083 Fax  
 www.fastformliners.com



DRAWN BY: Petr L. 4/28/2015  
**PROPRIETARY AND CONFIDENTIAL**  
 THE INFORMATION CONTAINED IN THIS  
 DRAWING IS THE SOLE PROPERTY OF  
 FAST FORMLINERS. ANY  
 REPRODUCTION IN PART OR AS A WHOLE  
 WITHOUT THE WRITTEN PERMISSION OF  
 FAST FORMLINERS IS PROHIBITED.

SHEET SIZE  
**11"x17"**  
 DO NOT  
 SCALE  
 SHEET 1 OF 1

**20028**

20028Reveal

REV. 4/28/2015

NOTES:

APPROVAL SIGNATURE:

Please provide a signature in this box to indicate that this drawing has  
 been approved and that FAST FORMLINERS may begin production.