

Concrete

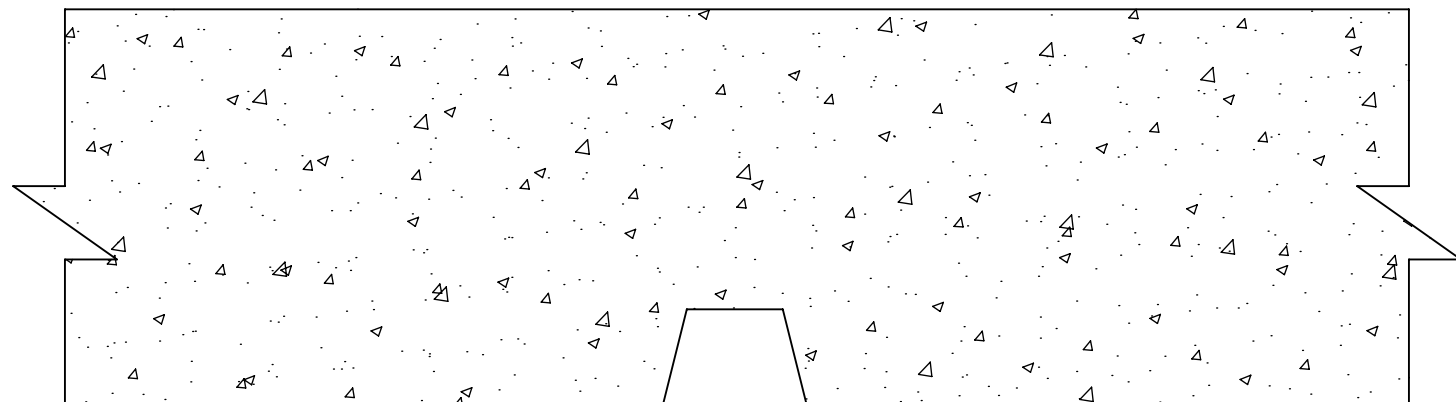

Reveal Strip

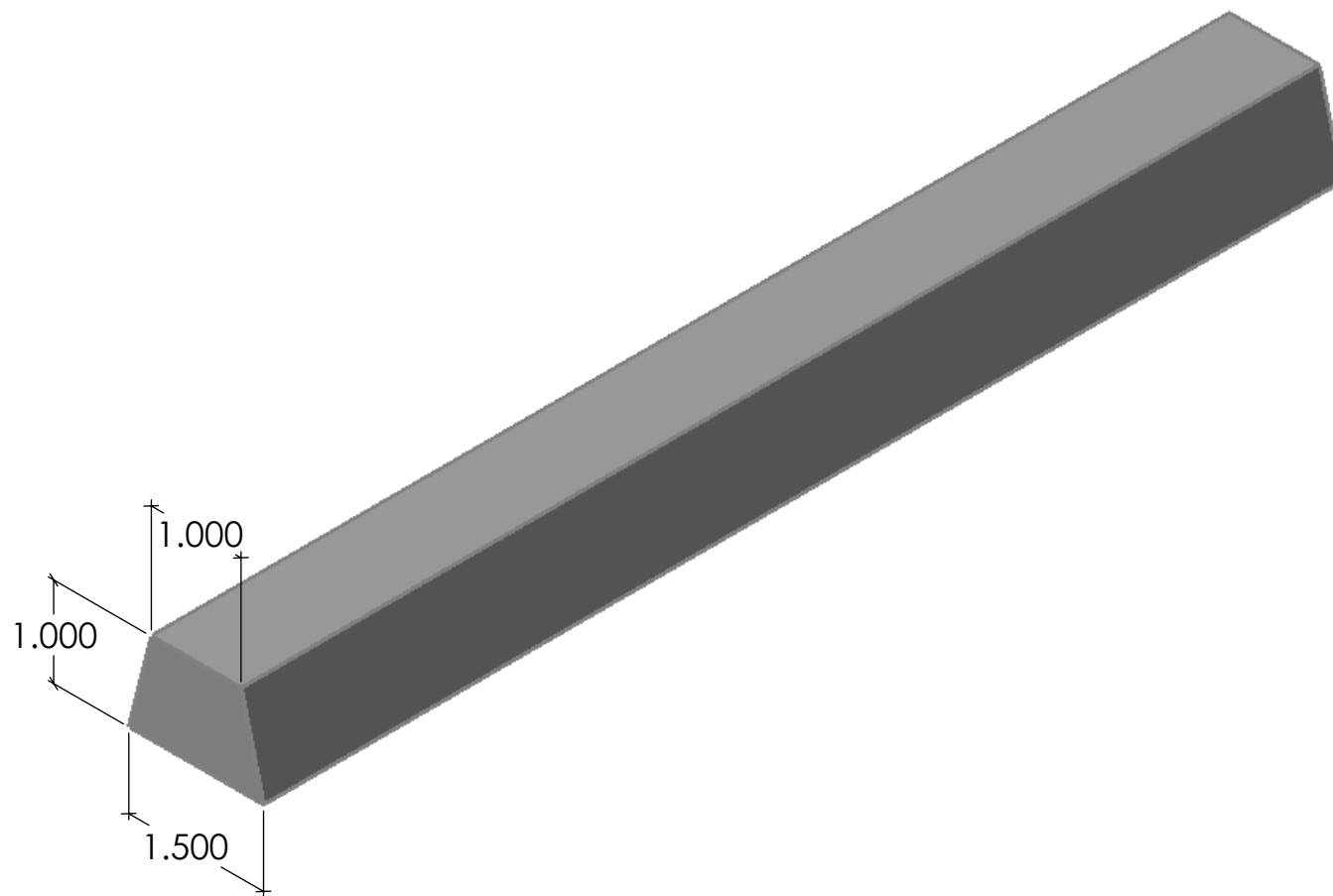

FAST FORMLINERS CO.
1005 Miller Drive, St. Clair, MO 63077
636-322-0080 Phone 636-322-0083 Fax
www.fastformliners.com



DRAWN BY: Petr L. 4/23/2015
PROPRIETARY AND CONFIDENTIAL
THE INFORMATION CONTAINED IN THIS
DRAWING IS THE SOLE PROPERTY OF
FAST FORMLINERS. ANY
REPRODUCTION IN PART OR AS A WHOLE
WITHOUT THE WRITTEN PERMISSION OF
FAST FORMLINERS IS PROHIBITED.

SHEET SIZE
11"x17"
DO NOT
SCALE
SHEET 1 OF 1

20011

20011Reveal

REV. 4/23/2015

NOTES:

APPROVAL SIGNATURE:

Please provide a signature in this box to indicate that this drawing has been approved and that FAST FORMLINERS may begin production.