

Concrete

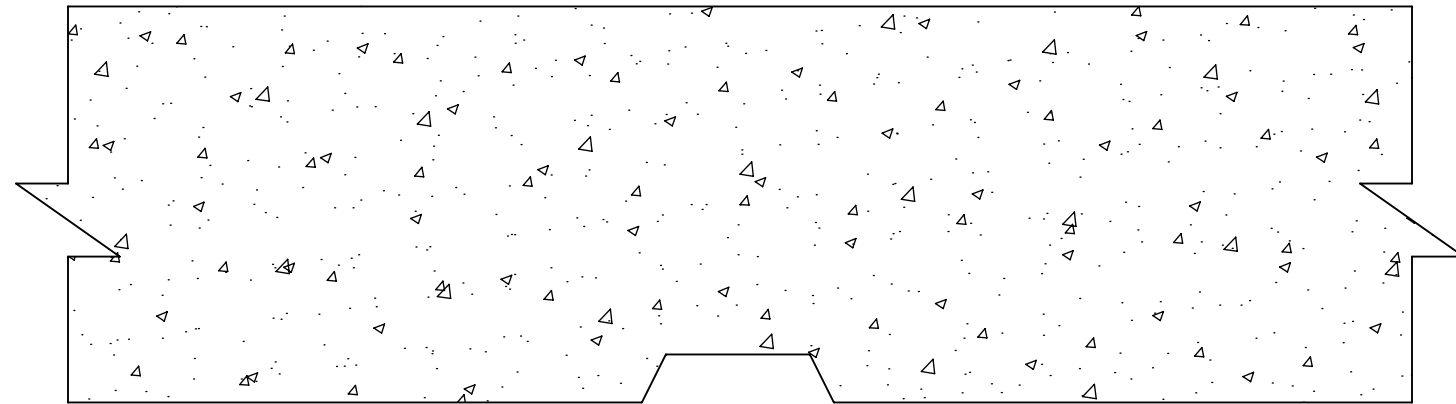

Reveal Strip

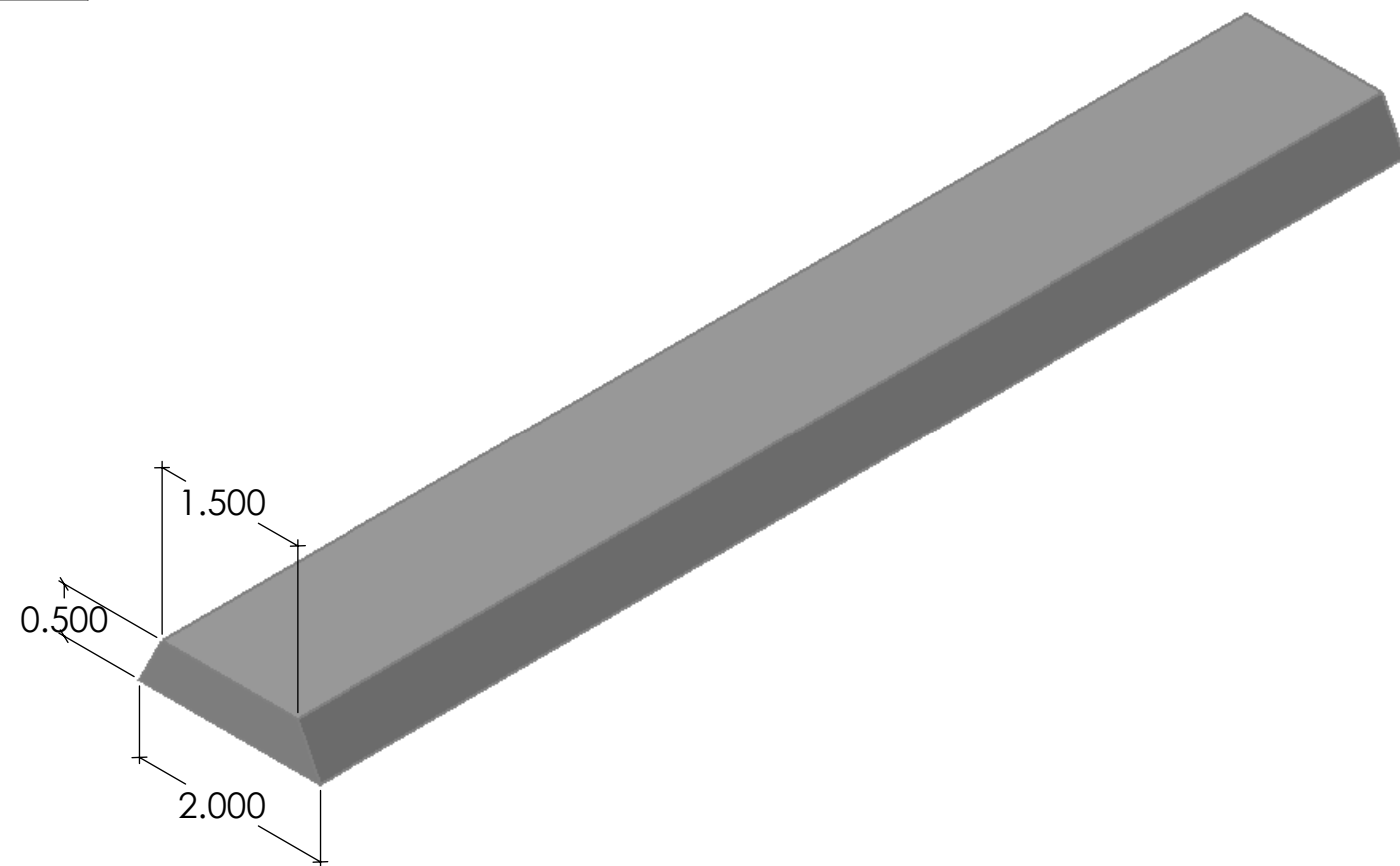

FAST FORMLINERS CO.
 1005 Miller Drive, St. Clair, MO 63077
 636-322-0080 Phone 636-322-0083 Fax
 www.fastformliners.com



DRAWN BY: Petr L. 4/28/2015
PROPRIETARY AND CONFIDENTIAL
 THE INFORMATION CONTAINED IN THIS
 DRAWING IS THE SOLE PROPERTY OF
 FAST FORMLINERS. ANY
 REPRODUCTION IN PART OR AS A WHOLE
 WITHOUT THE WRITTEN PERMISSION OF
 FAST FORMLINERS IS PROHIBITED.

SHEET SIZE
11"x17"
 DO NOT
 SCALE
 SHEET 1 OF 1

20034
 20034Reveal REV. 5/5/2015

NOTES:

APPROVAL SIGNATURE:
 Please provide a signature in this box to indicate that this drawing has
 been approved and that FAST FORMLINERS may begin production.